

Distributional Analysis of Gunnison's Prairie Dog (*Cynomys gunnisoni*) on the Navajo Nation and Reservation of the Hopi Tribe

Final Report



Distributional Analysis of Gunnison's Prairie Dog (*Cynomys gunnisoni*)
on The Navajo Nation and Reservation of the Hopi Tribe

Kristine Johnson, Zoology Coordinator
Teri B. Neville, GIS Coordinator
Natural Heritage New Mexico
Museum of Southwestern Biology
University of New Mexico

&

David Mikesic, Zoologist
Navajo Natural Heritage Program
The Navajo Nation

&

Darren Talayumptewa
Department of Natural Resources
The Hopi Tribe

Submitted to
U.S. Fish and Wildlife Service, Tribal Landowner Incentive Program

20 April 2010

Cover photo by David Mikesic

Table of Contents

Abstract.....	iv
Acknowledgments.....	v
Introduction.....	1
The Navajo Nation and The Hopi Tribe.....	1
Gunnison’s Prairie Dogs.....	1
Landscape-Scale Prairie Dog Survey.....	3
Methods.....	5
Study Area.....	5
Predictive Model of Suitable Habitat within the GPD Range.....	6
Photo Interpretation.....	7
Field Checking.....	9
Data Analyses.....	12
Results.....	14
Photo Interpretation.....	14
Field Checking.....	14
Vegetation in Study Areas.....	14
Towns.....	15
GPD Distribution.....	16
Transect Area.....	16
Year-to-Year Changes.....	17
Percent of Area Active.....	18
Modeling Active GPD Area.....	18
Discussion.....	19
Method Advantages.....	19
Method Disadvantages.....	19
Variation in Accuracy Across Study Areas.....	20
Conclusions.....	21
Education Project.....	21
Matching Fund Obligations.....	22
Literature Cited.....	22
Appendix A. Gunnison’s Prairie Dog Educational Brochure.....	26
A.1. Front page of four-fold educational brochure produced to exhibit importance of Gunnison’s Prairie Dog on the Navajo Nation.....	26

Appendix A.2. Back page of four-fold educational brochure produced to exhibit importance of Gunnison’s Prairie Dog on the Navajo Nation.	27
---	----

List of Figures

Figure 1. Range of GPD, showing boundaries of Navajo Nation and Reservation of the Hopi Tribe.	2
Figure 2. GPD range, showing land ownership.	5
Figure 3. Suitable GPD habitat within GPD range.	6
Figure 4. Priority ranks of DOQQs for survey, based on habitat suitability.	8
Figure 5. Photo-interpreted DOQQs.	9
Figure 6. Fixed kernel analysis of GPD polygon distribution.	10
Figure 7. Schematic of 2-km field transects used to field check photo-interpreted polygons.	11
Figure 8. Field tracks and results, both used and unused in the predictive model.	13
Figure 9. Photo-interpreted prairie dog disturbance.	16
Figure 10. Aggregated polygons within 500 m of one another.	18

List of Tables

Table 1. Number and area of polygons delineated, by study area.	14
Table 2. Field checking results by polygon, town, and transect.	15
Table 3. GPD disturbance on field transects versus interpreted imagery, by field study site and notes on dominant vegetation structure.	17
Table 4. NNHP matching fund obligation.	22

Abstract

The Navajo Nation and Hopi Tribe, in collaboration with Natural Heritage New Mexico of the University of New Mexico Biology Department, conducted a survey of Gunnison's prairie dog (GPD) disturbance on suitable habitat within the lands of both Tribes. We used standard photo-interpretive techniques to survey 1,654 digital orthophoto quarter quads (DOQQs) for ground disturbance caused by GPD. The surveyed area covered 7,944,262 ha. To assess accuracy, field observers walked 101, 2 km transects on the Navajo Nation and 50 on the Hopi Reservation, distances of approximately 202 and 100 km, respectively. On the surveyed DOQQs we delineated 40,587 ha of apparent GPD disturbance. We found apparent GPD disturbance that, when confirmed on the ground, will extend the GPD range up to 50 km to the northwest. This method allows for large landscape-scale survey at reasonable cost and provides spatial data useful for GIS analyses. Accuracy at detecting areas of heaviest GPD activity is reasonably good, but accuracy at estimating actual colony area is poor. To address this shortcoming, we used estimated rates of false positive errors, false negative errors, and known proportion of towns active to create a model to estimate actual area of active GPD disturbance on the ground. This model estimated the area of active GPD towns on the Navajo Nation and Reservation of the Hopi Tribe at 102,615ha.

Acknowledgments

We thank the UNM students and staff who contributed to the project, especially to our photo interpreters, Brandon Lee Drake, Mitch Dunaway, Brian Kramer, and Jacqueline Smith. Mitch Dunaway, Ryland Hutchins, and Brandon Lee Drake performed valuable work in the field and office to further develop our interpretive strategies. Jacqueline Smith and Benjamin Kessler provided valuable research and technical assistance for development of the education project.



Photo by David Mikesic

Introduction

The Navajo Nation and The Hopi Tribe

The Navajo Natural Heritage Program (NNHP) is a section of The Navajo Nation Department of Fish and Wildlife (NNDFW) and is funded by a Bureau of Indian Affairs P.L. 93-638 contract to maintain a database of rare and threatened species on The Navajo Nation. The NNHP is also a member of the NatureServe Network, which works to conserve the world's biodiversity through collection and interpretation of data on rare species and ecosystems. The NNDFW's Plan of Operation outlines the responsibilities of NNHP to be "gathering and organizing technical data on the existence, status and distribution of rare plants, animals or habitat for the purpose of biological land conservation planning and assessing impacts to the natural environment." The NNHP also maintains the Navajo Endangered Species List (NESL), which is approved by the Resources Committee of The Navajo Nation Council. Navajo Nation Code (17 NNC § 507) makes it "unlawful for any person to take, possess, transport, export, process, sell or offer for sale or ship" any species listed as 'endangered' on the NESL. Under this Code, "take," means "the hunting, capturing, killing in any manner or the attempt to hunt, capture or kill in any manner..." However, habitat protection, per se, is not afforded under the NNC.

The Navajo Nation occupies over 8 million ha (31,154 mi²) in Arizona, New Mexico and Utah (including tribal ranches). The Reservation of The Hopi Tribe occupies 607,000 ha (2,343 mi²) and is located in Arizona within the exterior boundaries of The Navajo Nation (Figure 1). The recognized range of the Gunnison's prairie dog (GPD, *Cynomys gunnisoni*) includes the Colorado Plateau in southeastern Utah, southwestern Colorado, northern Arizona, and much of northern and central New Mexico (Fitzgerald et al. 1994). Ninety-nine percent of Hopi Lands (603,003 ha) and 75% of Navajo Lands (6,084,906 ha) are within the range of the GPD (Figure 1); however, a percentage of these lands is not potential habitat for GPDs.

The Gunnison's Prairie Dog Conservation Assessment estimated that nearly half (49%) of the land within the gross and predicted range of the GPD in Arizona is under Tribal ownership (Seglund et al. 2005). Although this estimate is high, the Navajo Nation is nonetheless the second-largest single landowner in the range and the largest owner of suitable GPD habitat (see Study Area, below). Thus, an assessment of occupied GPD habitat on Tribal lands is critical to an accurate range-wide assessment of the species.

Gunnison's Prairie Dogs

Prairie dogs are considered keystone species in desert environments due to their burrowing and foraging activities and colonial nature. Their burrow systems provide structural habitat in an otherwise homogenous landscape and are used by a large number of other vertebrates and invertebrates. Prairie dogs alter plant species composition and affect ecosystem processes, and the areas occupied by colonies therefore have distinct vegetation structure and composition compared to the surrounding landscape. Prairie dogs typically constitute an abundant and stable prey source for a number of mammalian and avian predators (Seglund et al. 2005).

Oldemeyer et al. (1993) concluded that the total area occupied by all prairie dog species has declined by 98% since the 1800s. Petitions have previously been filed to list the black-tailed prairie dog (*Cynomys ludovicianus*) and the white-tailed prairie dog (*Cynomys leucurus*) under the Endangered Species Act (National Wildlife Federation 1998; Biodiversity Legal Foundation et al. 1998; Center for Native Ecosystems et al. 2002). The U.S. Fish and Wildlife Service (USFWS) was petitioned by the Forest Guardians and 73 others to list GPDs under the Endangered Species Act on 23 February 2004. The petitioners (Forest Guardians et al. 2004) asserted that all five federal listing criteria applied to the GPD. These threats include:

1. present or threatened destruction, modification, or curtailment of its habitat or range;
2. over-utilization for commercial, recreational, scientific, or educational purposes;
3. disease or predation;
4. inadequacy of existing regulatory mechanisms; and
5. other natural or man-made factors affecting its continued existence.

In 2008, the USFWS ruled that federal listing is warranted for the GPD montane population of south-central Colorado and north-central New Mexico. Other GPD populations were not determined to qualify for listing at that time (USFWS 2008).

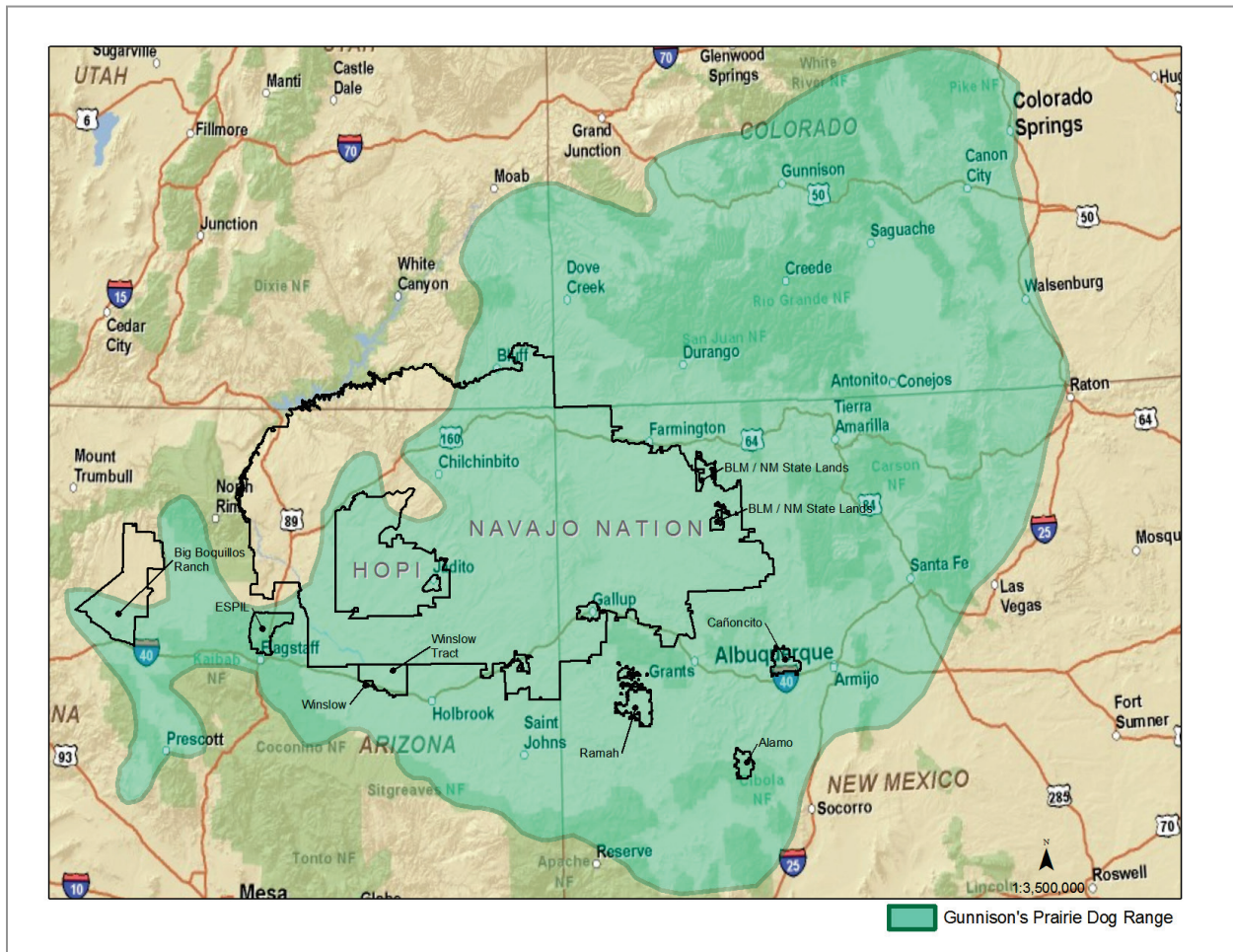

Figure 1. Range of GPD, showing boundaries of Navajo Nation and Reservation of the Hopi Tribe.

Most of the threats to GPDs that are found range-wide are also recognized on Navajo and Hopi Tribal Lands.

1. Habitat has been altered and lost due to home-site and other human infrastructure development such as agriculture, oil/gas exploration and development, and livestock grazing.
2. Recreational shooting of GPDs on Navajo and Hopi lands occurs locally, but not at the same magnitude as elsewhere. A Navajo Nation small game permit is required on Navajo lands, but there is no closed season.
3. GPDs are highly susceptible to sylvatic plague, and die-offs have occurred in recent years on The Navajo Nation (Wagner and Drickamer 2003, Seglund et al. 2005).
4. The Navajo Nation and the Hopi Tribe currently have limited regulatory mechanisms in place to protect existing GPD populations.
5. Poisoning of GPDs on Navajo Nation lands occurs within at least one large agricultural area, and lands of both Tribes are experiencing drought conditions that can greatly affect the forage and habitat structure within GPD colonies. No studies are in progress to evaluate the effects of any of these threats or the cumulative impacts of all threats on Navajo and Hopi lands.

Wagner and Drickamer (2003) examined GPDs in northeastern Arizona, including The Navajo Nation, and arrived at several startling conclusions. They determined that in the last 7-15 years, a large reduction in the number of active GPD colonies has occurred in Arizona, primarily due to outbreaks of plague (the dominant negative impact on the Arizona populations). They also determined that the size of individual GPD colonies shows significant temporal and spatial variation. Much of this variation may be attributed to repeated plague outbreaks and subsequent recovery of local populations. This is likely true elsewhere within Navajo and Hopi lands. For example, in the New Mexico portion of The Navajo Nation, GPD colonies were mapped along a 70-mile stretch of U.S. Highway 491 during 2001 and 2003/04. A total of 37 prairie dog colonies was located, and although the colonies were thriving in 2001, most were abandoned or nearly so in 2003 (Seglund et al. 2005).

Landscape-Scale Prairie Dog Survey

A large landscape-scale survey for GPDs presents several logistical challenges. Typically, small-scale surveys of prairie dog habitat are expensive and time-consuming and require ground-based surveys to accurately delineate prairie dog towns and determine occupancy. The NNHP located and mapped a number of GPD colonies in the southwestern portion of The Navajo Nation from 1994 to 1996. This work yielded 90 colonies in four complexes; however, the total survey area represented only a small portion of GPD lands on The Navajo Nation (Seglund et al. 2005). This effort revealed that ground survey and monitoring are unfeasible on areas the size of the reservations of The Navajo Nation and The Hopi Tribe.

Several attempts have been made to use fixed-wing aircraft to survey for prairie dog towns over large landscapes (Andelt et al. 2003, MacVean and Miller 2005). The accuracy of this method is questionable, and field visits are still necessary to determine occupancy. Andelt et al. (2003) compared survey results of two independent teams in fixed-wing aircraft. Compared to ground surveys, both teams overestimated lengths of GPD colonies along flight transects in Colorado and Utah. In addition, the results of the two teams were only weakly correlated. MacVean and

Miller (2005) also compared aerial transect data to ground-truthed data. They estimated that nearly half (42%) of towns identified by ground-truthing were missed during aerial surveys.

A third method, using remote sensing imagery to detect ground disturbance caused by prairie dogs, has met with mixed success. Because of its relatively low spatial resolution, satellite imagery proved only marginally useful for detecting prairie dog disturbance (Johnson et al. 2000). Analysis of high-resolution, digital aerial photography (digital orthophoto quarter quadrangles, DOQQs) has worked well for detecting black-tailed prairie dog disturbance (Johnson et al. 2003, 2004a) and has provided some success with GPDs (Johnson et al. 2004b, 2006a). Two types of prairie dog disturbance are evident on DOQQs. Mounds at burrow entrances show up as bright white dots, and areas of sparse vegetation around mounds are evident as lighter areas called “haloing.” DOQQ surveyors search digital imagery for these signature disturbance patterns.

DOQQ survey provides several advantages over other methods. First and possibly most important is access. In areas inaccessible due to land ownership or road scarcity, aerial photography can provide 100% coverage of the survey area. Cost of travel by vehicle and by foot in roadless areas makes ground survey of large areas prohibitively expensive (see above). Other remote-sensing methods avoid the access problem, but each poses its own difficulties. The aerial line-intercept method is expensive and of questionable accuracy (see above). IKONOS satellite imagery, which has high resolution, is very expensive for use over a large landscape, and image availability can be unpredictable.

The second major advantage of DOQQ survey is cost. Now that the utility of DOQQ imagery is becoming appreciated, agencies are purchasing this imagery and making it available at relatively low cost. Most of the cost of a DOQQ survey is labor, and labor costs may decline with the creation of automated methods.

Finally, remote-sensing methods provide spatial data, in the form of polygons that can be imported into a Geographic Information System (GIS), which allows analyses that would be impossible with point data from ground surveys or aerial transects. Archived aerial photos and GIS layers provide a permanent baseline record of prairie dog towns that is useful for monitoring.

Although DOQQ interpretation has proven to be the most useful method for surveying for prairie dogs over large landscapes, Johnson and colleagues have encountered a few challenges. First, for their initial survey, recent imagery was unavailable, making it difficult to determine if errors resulted from the DOQQ survey or from changes in prairie dog towns that occur naturally over time (Johnson et al. 2003, 2004a,b, 2006a). With a seven- or eight-year gap between the photos and field checking, it is difficult to estimate the rates of towns missed, lost, and gained, and thus it is difficult to estimate current town area and distribution from the DOQQ survey. Johnson et al. (2004b, 2006a) concluded that imagery made closer to the time of the DOQQ survey, combined with more extensive field checking, would greatly increase accuracy of area estimates based on DOQQ survey. Finally, GPDs create less obvious ground disturbance than do black-tailed prairie dogs, because they occur in smaller colonies and more shrubby habitats (Johnson et

al. 2004a, 2006a). The higher-resolution (0.15 m) DOQQs available for this project have improved accuracy of photo interpretation for GPDs.

Methods

Study Area

The estimated range of the GPD covers 28,090,077 ha in the Four Corners Region. New Mexico has the largest share of the GPD distribution with 39.77%, followed by Colorado with 30.8%, Arizona with 25.41%, and Utah with 4.03%.

The largest land ownership type within the GPD range is private with no restrictions on development (such as management for biodiversity); 30% of the range is owned and managed by multiple private parties. Collectively, Tribes are the second-largest landowners, with 25% of the land within the GPD range. Navajo Nation owns 64% of Tribal lands within the GPD range. The Hopi Tribe owns 9% of tribal lands, and 4% are jointly owned by the Navajo Nation and Hopi

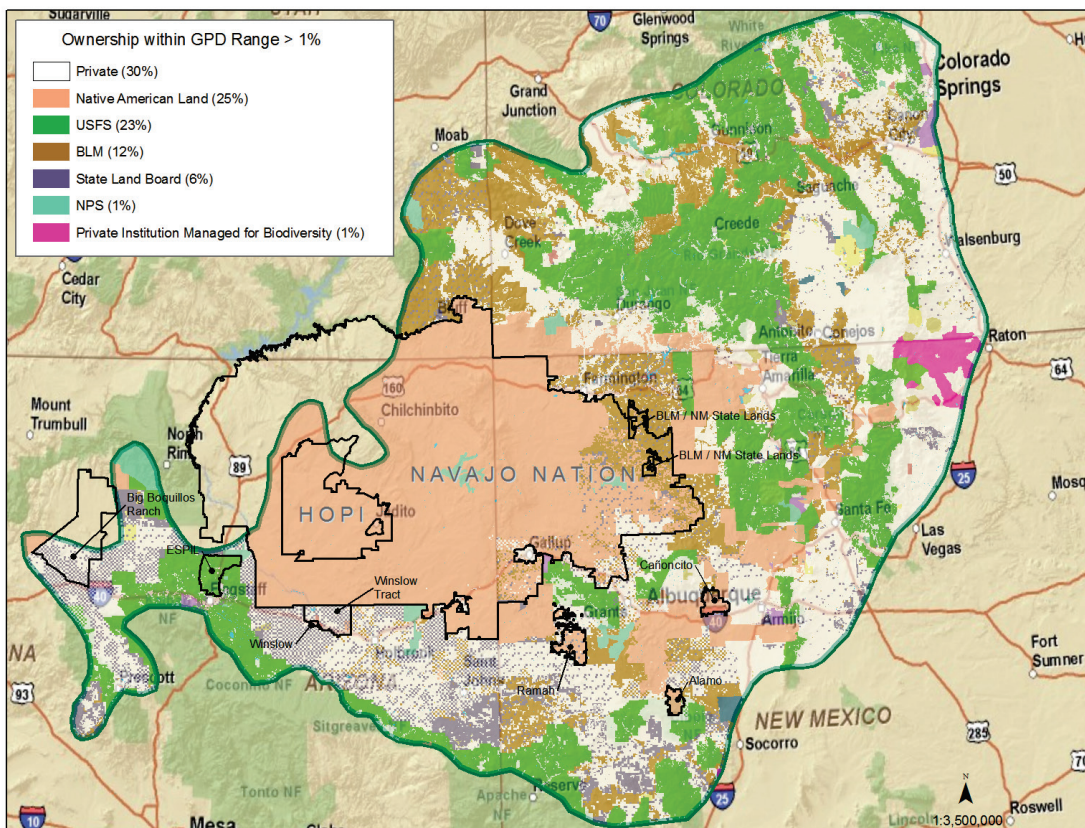

Figure 2. GPD range, showing land ownership.

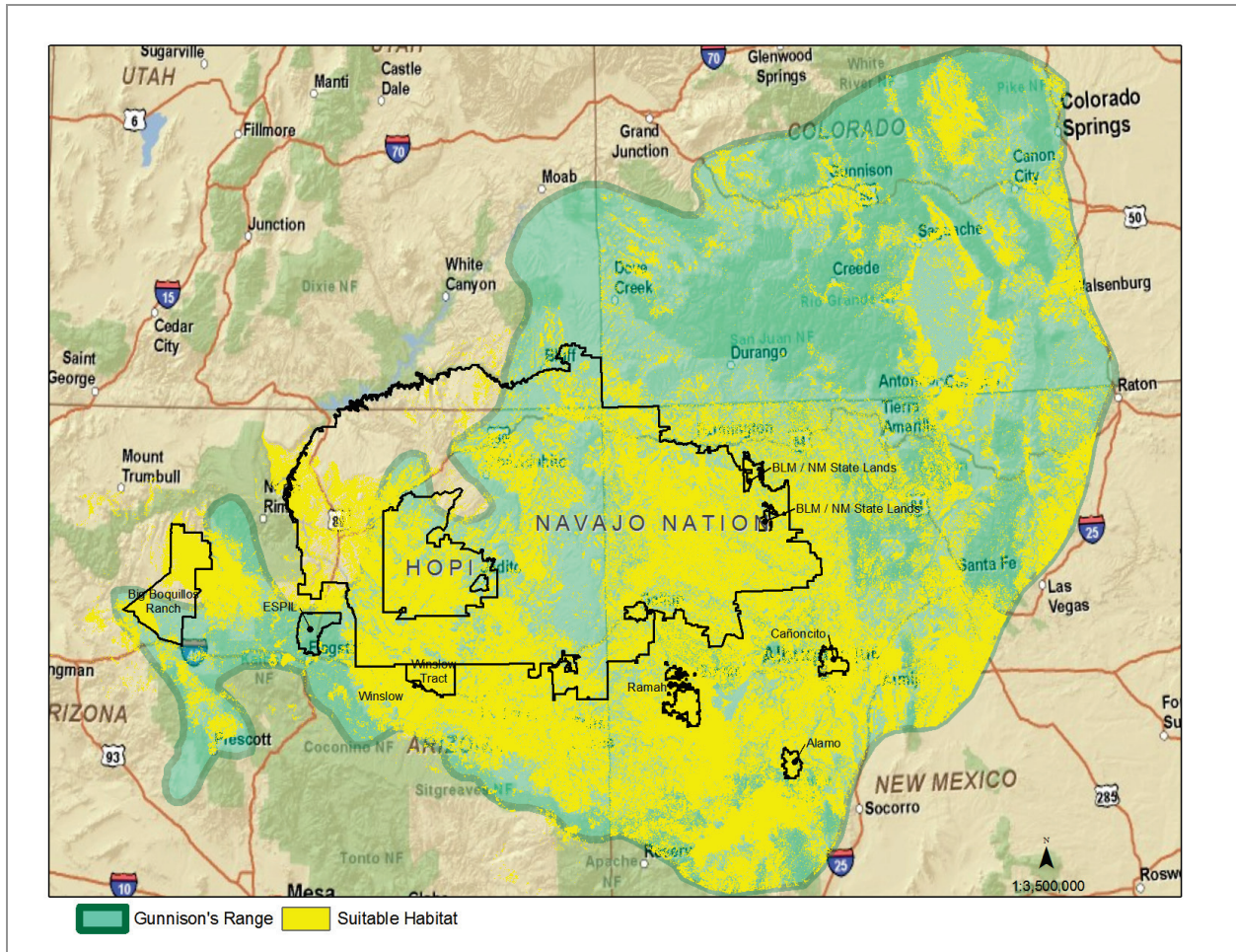

Figure 3. Suitable GPD habitat within GPD range.

Tribe. Together they own 19% of the GPD range. The largest single land manager within the GPD range is the US Forest Service, with 22%. The Bureau of Land Management falls in behind Navajo and Hopi with 12% (Figure 2). Distribution of suitable GPD habitat, however, is concentrated on private (36%) and Tribal lands (33%), followed by BLM with 13% (Figure 3). This means that the Navajo Nation is the largest single manager of suitable GPD habitat in the species' range, with jurisdiction over 24% of suitable habitat (Figure 3; Seglund et al. 2005, Neville and Johnson 2007, USGS Gap Analysis Program 2007).

Predictive Model of Suitable Habitat within the GPD Range

We first sought to identify potential GPD habitat, to allow us to focus the DOQQ surveys in areas having suitable habitat. Two GPD predictive range maps were available for New Mexico (New Mexico Cooperative Fish and Wildlife Research Unit 2005, Seglund et al. 2005). Both models were developed under the USGS National Gap Analysis Program (2004) using Ecological Systems (Comer et al. 2003). We had previously compiled field verified data from tribes, federal agencies, state agencies, private companies, and conservation groups into a GIS of GPD colonies in New Mexico (Johnson et al. 2004b). In addition to these data, we used observation data from NMDGF (James Stuart), field observations from Hawks Aloft, and

archived data from the NMBiotics database (Natural Heritage New Mexico 2010) in a GIS to test the accuracy of the two existing predictive range maps.

Initially we tried to increase the accuracy of the Seglund et al. (2005) predictive range map by adding land cover classes that contained known GPD towns in New Mexico but that were not represented in the model. In the end, we decided that further “remodeling” efforts would be more time consuming than developing a new model from scratch. For the new model, we followed the approximate methodology established by Seglund et al. (2005) and Southwest ReGAP (New Mexico Cooperative Fish and Wildlife Research Unit 2005). We selected map units for the model based on our data for existing and historical GPD towns (Neville and Johnson 2007).

We used the Southwest ReGAP land cover (USGS National Gap Analysis Program 2004, Lowry et al. 2005) digital map to identify land cover classes that directly overlaid our field verified datasets. We evaluated map units in the model by comparing the number of known towns to the distribution within the GPD range of the map unit in question. We assumed that GPD would be fairly generally distributed in suitable land cover types. If relatively few confirmed prairie dog localities occurred within a map unit that was abundant within the GPD range, or if many towns occurred in a very small map unit or part of a map unit, we re-examined the map units. In many cases, we concluded that the towns actually belonged in a neighboring map unit and were misplaced due to inaccuracy of the land cover map or town locations. In addition, some map units were eliminated based on literature or our knowledge of GPD biology. For example, we eliminated Colorado Plateau Mixed Bedrock Canyon and Tableland because it is unlikely that prairie dogs would occupy this rocky land cover class (Neville and Johnson 2007). Using a combination of on-screen visual interpretation of neighboring map units, topographic position, and GPD field locality, we made qualitative assessments for including or eliminating map units. Following both Seglund et al. (2005) and the SWReGAP (New Mexico Cooperative Fish and Wildlife Research Unit 2005) models, we further restricted the land cover classes by slope.

Using our habitat model, we calculated the percent cover of suitable habitat and identified any known active or inactive colonies within each DOQQ, then assigned a rank from 1-4, with 1 being the highest priority (Figure 4). A value of zero was placed on unsuitable map units. Ancillary GIS layers such as elevation contours, soil maps (Soil Survey Staff, NRCS, USDA - SSURGO and STATSGO), and SWReGAP landcover were used to aid in distinguishing prairie dog habitat characteristics. For example, if the elevation contours showed steep slopes, we determined the surface disturbance was probably due to rock outcrops, as verified in our initial field visits. Our soil maps were useful, particularly for New Mexico, to identify shallow soils unsuitable for prairie dog burrows.

Photo Interpretation

The DOQQs were commissioned by The Bureau of Indian Affairs for the area of the Navajo Nation. We surveyed 1,654, 1m resolution DOQQs scaled to 1:12,000 following National Map Accuracy Standards. DOQQs surveyed covered 7,944,261.66 ha. Surveyed DOQQs are shown in Figure 5.

We used standard aerial photo interpretive techniques (Lillesand and Kiefer 1987) to survey suitable habitats on the Navajo Nation and the Reservation of The Hopi Tribe. We excluded

Tribal lands that fell outside the historical range, quadrangles that include areas not on Tribal lands, and separately-managed areas and in-holdings.

Student and technician interpreters viewed each image in ArcGIS Desktop 9.3.1 displayed at a resolution of 1:1,000 to 1:2,000, depending on the quality of the image. The new imagery is of higher quality than that used in previous studies (Johnson et al. 2003; 2004a,b; 2006a); however, to compensate for graininess or other variation in image quality, we applied various raster enhancements such as statistical contrast stretches and manual adjustments to contrast and brightness (Johnson et al. 2006a).

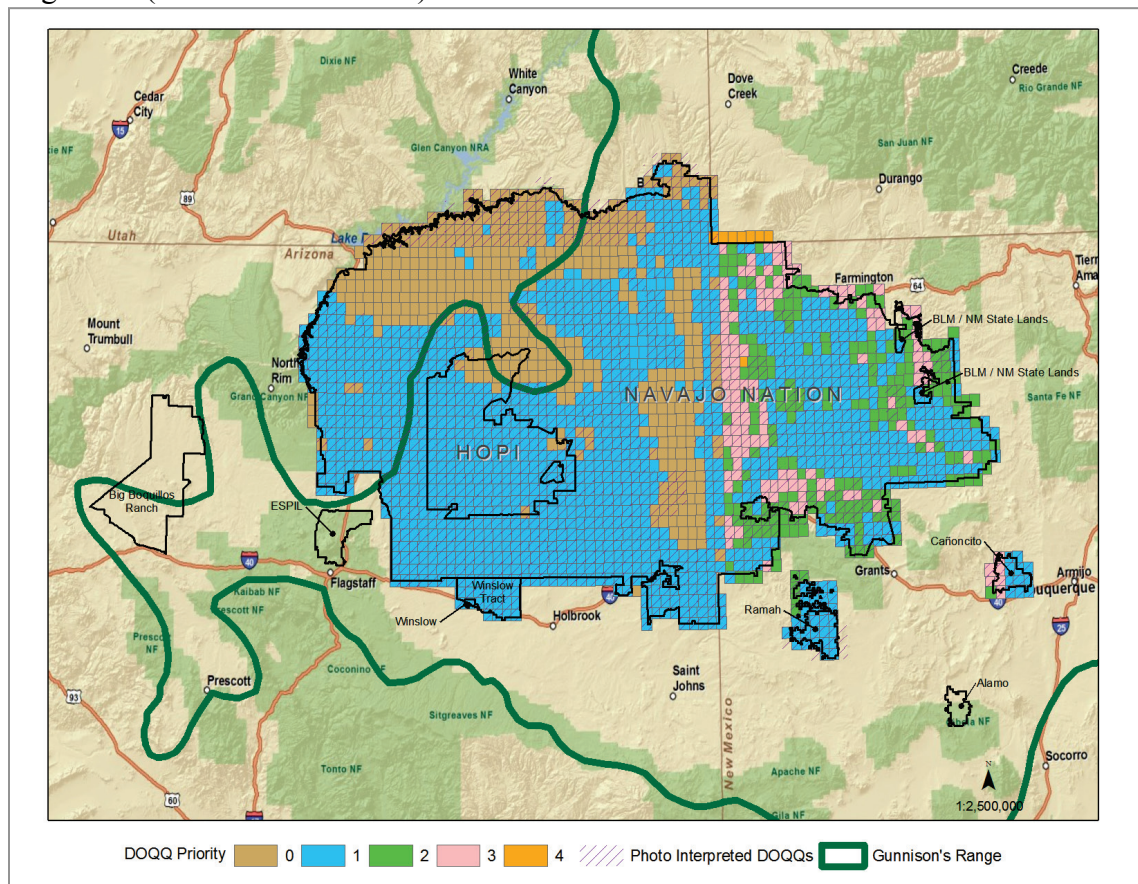

Figure 4. Priority ranks of DOQQs for survey, based on habitat suitability.

Because each quad typically occupies more than one full screen, interpreters systematically scanned the screen left to right, down, right to left, and so on, until the entire screen had been viewed. They then moved one screen to the right (or down) and repeated the process until the entire image had been viewed. When characteristic prairie dog disturbance was identified, they digitized a polygon of the clipped-vegetation halos surrounding the mounds. If no clip line was evident, the polygon connected the outermost mounds.

A unique site identification number was assigned to each polygon, and the area and perimeter of the polygon were automatically calculated using GIS software. After the first interpreter identified a site, a second person reviewed a subset of images as a quality check. Initially, interpreters were told to classify each disturbance polygon as “likely” or “questionable” GPD disturbance. Interpreters varied widely in their confidence and in the proportion of polygons they

classified as questionable. In the final dataset, only 5% of all polygons were classed as questionable. Therefore, we included all questionable polygons in the dataset along with the likely towns.

Field Checking

Photo interpreters made five field trips to the study area to identify and attempt to correct errors in photo interpretation. Following the 2007 field trips, the interpreters created visual keys of the DOQQs for distinguishing prairie dog disturbance from other surface perturbations such as harvester ant mounds, grazing, and manmade disturbance. These keys were used to train new interpreters and as a reference for classifying disturbance.

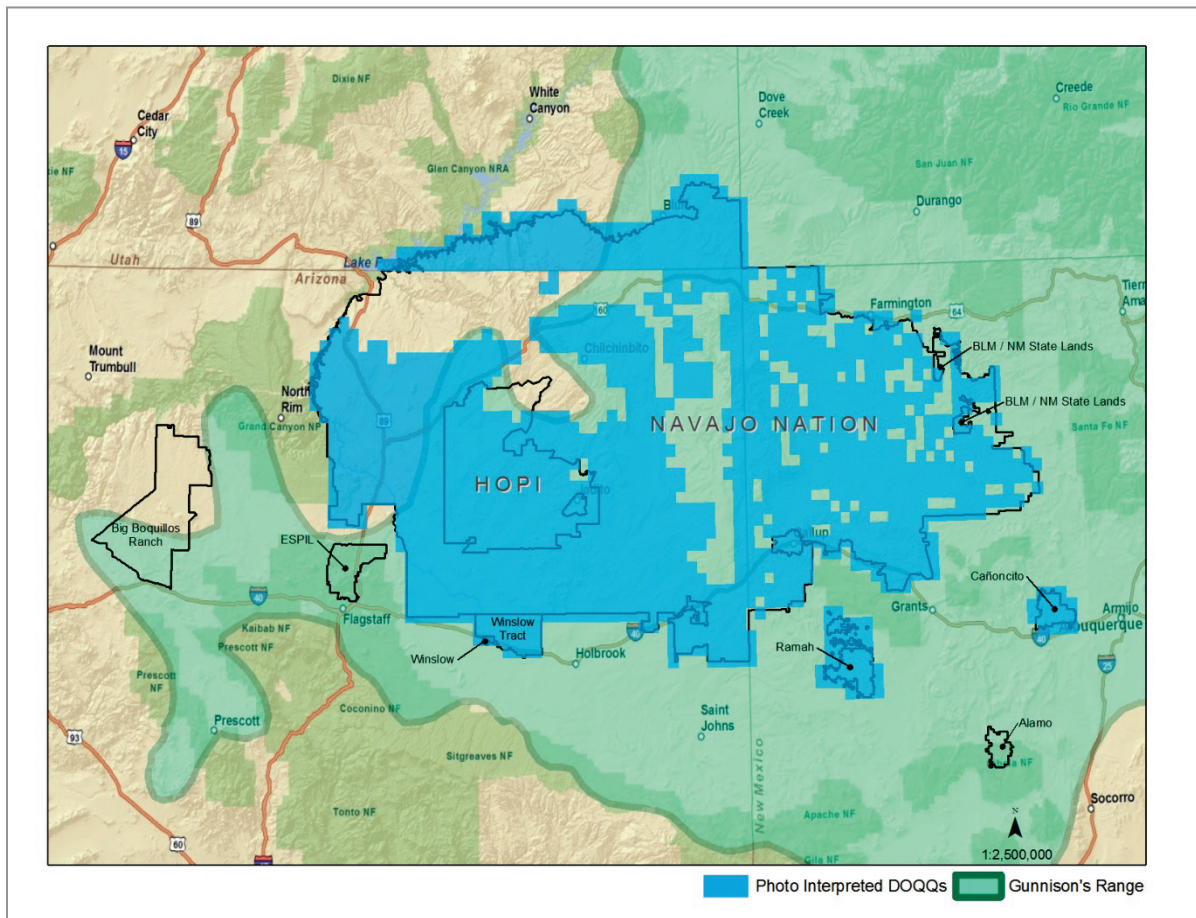

Figure 5. Photo-interpreted DOQQs.

During the summer of 2008, we developed a method for field checking photo-interpreted polygons based on photo interpretation completed to-date. Our goals for field checking were to determine:

1. a rate for polygons misidentified as GPD disturbance (errors of commission), or false positive rate,
2. a rate for towns we might have missed on the imagery (errors of omission), or false negative rate, and

3. a rate of change per year, to allow us to separate changes in the spatial distribution of towns over time from errors of interpretation.

To focus field checking in areas with GPD disturbance, we ran descriptive spatial statistics on the center points of photo-interpreted polygons to determine distances and clustering among prairie dogs. We identified clusters of towns using the Least-Squares Cross Validation Fixed Kernel Density Estimator (LSCV, Beyer 2004) and selected six areas wherein we would sample field transects. The LSCV method helps to:

1. aggregate areas of towns to indicate a pattern of distribution in the landscape,
2. provide a statistical method for grouping the non-normally distributed towns (e.g., based on distance between towns), and
3. provide a non-parametric measure of probabilities to be used for field sampling analyses (Figure 6). Within each of the study areas selected (Hopi North, Hopi South, Chinle Valley, Lower Greasewood, Huerfano, and Crownpoint,), the mean distances between towns ranged from 313-935 m. We used these results to determine a length for field transects. At the time we developed the areas to field verify, Chinle Valley had not yet been photo-interpreted and therefore not included in the LSCV. We exchanged the Ramah study area for Chinle Valley when field surveys began.

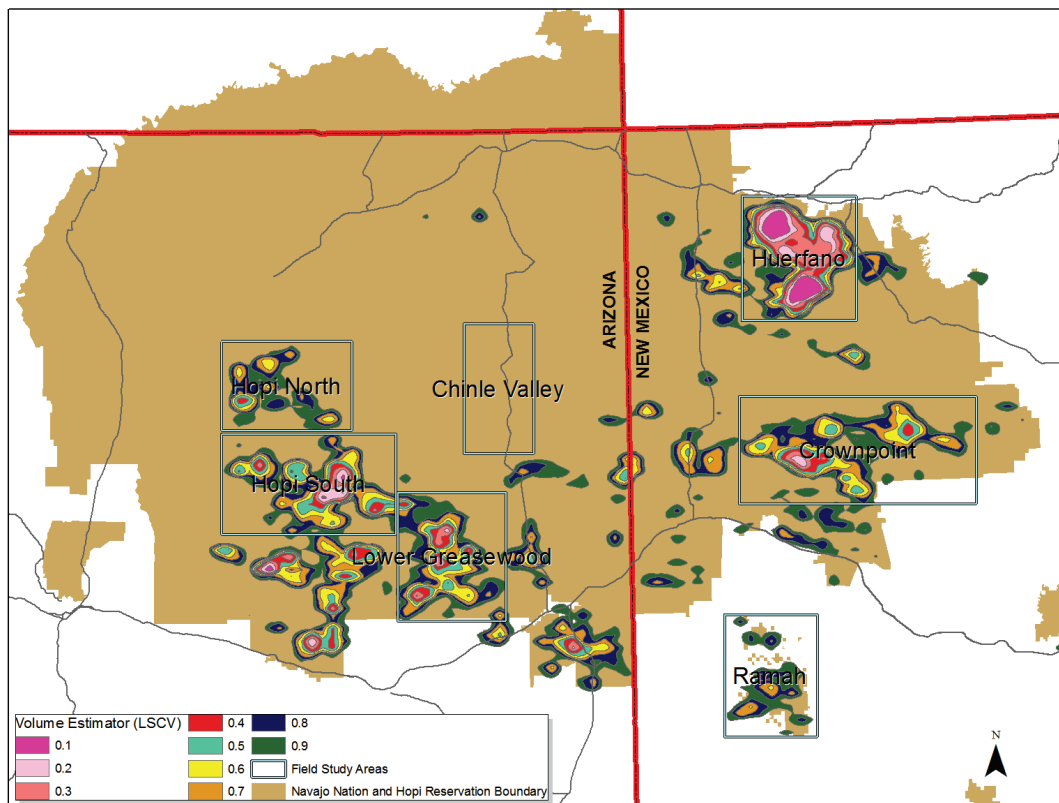

Figure 6. Fixed kernel analysis of GPD polygon distribution.

To develop a field checking method, we first performed simulations in GIS. We tried various shapes and lengths of transects, attempting to balance the amount of field effort required with the

amount of information gained. Given the distribution and size of prairie dog disturbance we had detected on the imagery and the GIS spatial analyses, we determined that a 2 km transect would provide the best balance of time/effort with information gained. We settled on a triangular transect that would place the end of the transect at the starting point, near the vehicle. A second advantage of the triangular transect over a linear one is that the area inside the transect could be used to compute active area of GPD disturbance for comparison with two-dimensional polygon data. A set of randomly-selected towns was identified as starting points.

NHNM provided center points of interpreted polygons for each study area as potential starting points for transects. Field staff at the Navajo Nation and the Hopi Tribe determined the actual transects walked, based on a number of criteria, including proximity to accessible roads, presence of homes or other human structures, and proximity to adjacent transects. Generally, transects were selected for field verification if they were near accessible roads, without homes or other inhabited structures, and not overlapping previously-analyzed transects. For statistical analyses, we estimated that between 20 and 30 transects were needed in each study area; however, the actual number walked was a function of these three criteria. Further, field staff determined whether transects would be walked in a ‘clockwise’ or ‘counter-clockwise’ direction based on the presence of homes and overlapping adjacent transects (Figure 7).

Pedestrian surveys were conducted on each 2km transect to determine the extent that prairie dog burrows extended throughout the transect. Prior to walking each transect, we projected the vertices of the transect using a handheld Global Positioning System (GPS) unit. From the start point provided by NHNM, the observer projected a new waypoint at 667 m and 30° for clockwise analysis or 330° for counter-clockwise analysis. This served as the precise location of the second vertex of the triangular transect. A second new waypoint was then projected from the first at 150° or 210° to create the third vertex of the triangle.

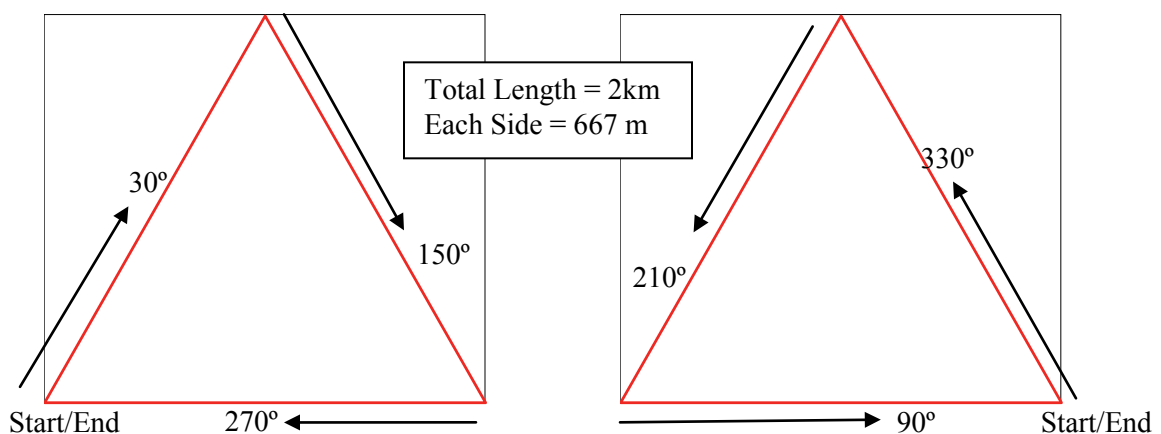

Figure 7. Schematic of 2-km field transects used to field check photo-interpreted polygons.

The observer began a survey by walking to within 1 m of the mid-point of the starting polygon (designated as “start/end”, Figure 7). At the starting point, the observer recorded whether any active or inactive prairie dog burrows were present. The observer then used the GPS unit to project a straight-line course to the second vertex, and walked toward that next vertex of the

transect. Upon arrival to within 1 m of the second vertex, the observer used the GPS unit to project a line to the third vertex. The transect continued until the observer returned to the start point.

If prairie dog burrows were present at the start point, the observer was vigilant to observe if, and where, the town ended. At the last observable burrow, the surveyor continued walking along the transect and began counting his/her paces. If no further burrows were observed within 50 paces (approximately 50 m), a waypoint was collected on the GPS to identify the 'end point' of the prairie dog town.

If burrows were not present at the start point, the opposite procedure would be employed. The observer was vigilant to record a waypoint at the first prairie dog burrow observed along the transect. This represented the 'start point' of the prairie dog town. The observer continued to walk the transect within the town, using the procedure described above to record the 'end point.'

Using this procedure, no start/stop waypoints were collected if prairie dog towns covered the entire transect, or if no prairie dogs were observed throughout the transect. Occasionally, a single prairie dog burrow was observed well away from the nearest town; no waypoints were collected for these single burrows. During all aspects of this procedure, the surveyor recorded town locations by observing burrows as far left, right, and forward as he/she could see. Thus, terrain and vegetation density may have been a factor in burrow detection along some transects. Towns were scored as 'active' if one or more burrows within a town showed signs of recent prairie dog activity, including direct observation of prairie dog, barking heard, fresh scat, or other compelling evidence of occupation.

Observers also provided a cursory examination of the vegetation composition throughout the transect and recorded the dominant plant species present along the transect. They also recorded any other unique ground-disturbance features (e.g., anthills, kangaroo rat mounds, rocks, etc.) that may have been interpreted as prairie dog burrows from aerial photo analyses. The track recorded by the GPS unit during the transect analysis, along with the start/stop waypoints, were downloaded to a computer and compiled for NHTM use in analysis.

This method provided a check of the starting polygon and any polygons lying along the transect lines. Discrepancies between these polygon areas and the areas delineated by the field observers contributed to the false positive rate. The method also provided locations of towns missed by the photo interpreter, contributing to the false negative rate. To determine an annual natural rate of change of town distribution, we field checked a subset of transects on the Navajo Nation one year after the 2008 check, plus or minus two weeks. All field checks on the Hopi Reservation were conducted in 2009 and none was repeated one year later. The annual rate of change provided a general idea of how much towns changed between years and allowed us to discriminate errors of interpretation from natural changes in town size and position. These three rates were incorporated into a model to estimate area of active towns over the project area.

Data Analyses

All spatial summary statistics and analyses were performed in ArcGIS Desktop 9.3.1. Statistical analyses of year 1-year 2 changes were performed in MS Excel 2007.

To compare interpreted polygons to field-delineated areas of GPD disturbance, we considered only the areas inside the triangular transects. For transects in which active segments of the transect included a corner of the triangle, we closed the corners of these smaller field-delineated polygons in GIS and added the areas of GPD disturbance (active and inactive) inside each triangular transect, to get an approximate area of GPD disturbance inside each triangular transect. If the field data showed only a line of GPD disturbance along one leg of a transect, we were unable to use the transect in the area analysis, because there was no way to delineate an area of activity (Figure 8). We were able to use 25 of 50 field transects from Hopi land and 48 of 101 transects from Navajo land for this area analysis.

We used these areas for comparison with the interpreted polygon areas inside the corresponding transects. In GIS, we clipped delineated polygons inside the transect at the transect line and added the areas of all delineated polygons that fell inside each field transect. We divided the areas of GPD disturbance from the field by the areas delineated on the imagery to get a ratio of field to image areas. These ratios were then used in the modeling to adjust for GPD disturbance missed by interpreters, or false negatives.

Interpreted polygons found to contain no GPD disturbance were classified as false positive areas for the modeling. We also computed the relative areas of active v. inactive polygons identified in the field to obtain a factor for adjusting the estimated town area to include only active (occupied) GPD towns.

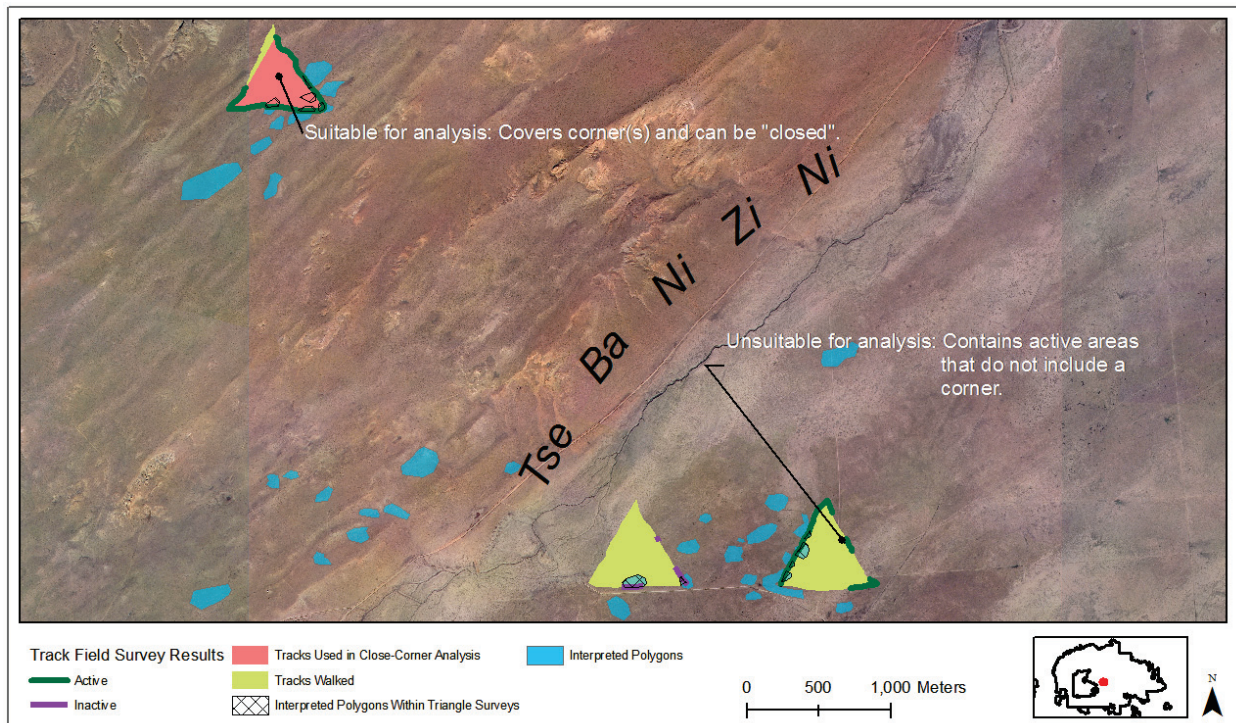

Figure 8. Field tracks and results, both used and unused in the predictive model.

Results

Photo Interpretation

We surveyed 1,654 DOQQs with a combined area of 7,944,262 ha. On the surveyed DOQQs we delineated 40,587.17 ha of ***photo-interpreted polygon area*** on the imagery of the Navajo Nation and Reservation of the Hopi Tribe. The mean polygon size was 3.58 ha (SD=6.40, range=0.06-161.13). Approximately 48% of this area was divided among six areas in which we conducted field checking. The other 52% of the polygon area was outside the field checked areas (Table 1). The field-checked sub-areas ranged from 157,827.43 to 440,773.21 ha in area. The amount of prairie dog disturbance we detected on the imagery varied more widely than the size of the sub-areas, from 882.56 ha to 8609.53 ha (Table 1). Of the field checked areas, we delineated the smallest area of GPD disturbance in Chinle Valley (882.56 ha in 577 polygons). Hopi North also had few polygons and relatively low GPD disturbance (1708.37 ha in 388 polygons). The field-checked area with the most GPD disturbance was Huerfano (8609.53 ha in 2252 polygons). Outside areas had approximately 21,181 ha of apparent GPD disturbance in 5311 polygons, comprising 52.19% of the surveyed area, 52.19% of the polygon area, and 46.95% of the polygons delineated.

Table 1. Number and area of polygons delineated, by study area.

Study Area	Number Polygons	Polygon Hectares	% of Total
Outside Areas	5311	21180.84	0.52
Chinle Valley	577	882.56	0.02
Crownpoint	994	2146.11	0.05
Hopi North	388	1708.37	0.04
Hopi South	998	3018.71	0.07
Huerfano	2252	8609.53	0.21
Lower Greasewood	792	3041.05	0.07
TOTAL	11312	40587.17	1.00

Field Checking

Vegetation in Study Areas

The vegetation composition and density varied considerably between transect study areas despite all areas being contained within Great Basin Desert Grasslands (Brown et al. 1979). The Lower Greasewood study area generally had the most flat, open grasslands, with large patches of bare ground. This area was dominated by grama (*Bouteloua* spp.) and other bunch grasses, with few scattered prickly-pear cactus (*Opuntia* spp.) and snakeweed (*Gutierrezia sarothrae*), and occasional narrow-leaf yucca (*Yucca glauca*). This area contained the most sparse, lowest-growing vegetation of the study areas. The Chinle Valley area also contained large patches of open ground and the same species as Lower Greasewood. However, these transects also had areas with taller and more dense shrubs such as Mormon tea (*Ephedra* spp.), four-wing saltbush (*Atriplex canescens*), and globemallow (*Sphaeralcea* spp.). Exotic plants, such as Russian thistle (*Salsola* spp.), were also common here. Slight rolling hills occurred within parts of this study

area. The Huerfano study area contained the most intact grasslands of the four areas. These transects contained diverse grass and shrub species, similar to those listed above, with low occurrence of exotic species. Although the vegetation was generally denser in this study area compared to the previous two, the height of most vegetation was lower than that at Chinle Valley. Conversely, slight rolling hills were found on some Huerfano transects similar to the terrain within Chinle Valley. Most transects in the Crownpoint study area differed from the others by having shrubs (especially snakeweed) more dominant than grasses, and having more rigorous hilly terrain. These two factors decreased overall visibility along these transects. We do not have vegetation descriptions for Hopi North or Hopi South.

Towns

All transects were used to evaluate our success at the polygon, town, and transect scales. In the six areas, we checked 325 polygons delineated as GPD disturbance in the imagery (Table 2). Of these, 66.15% (215) were active towns and 16.92% (55) were inactive towns; thus, 83.07% of polygons identified contained GPD disturbance. In some cases, field checks found two or more delineated polygons to be a single GPD town. Combining these polygons and scoring them as a single town, we checked 215 towns and found 125 to be active and 41 to be inactive, meaning that 77.21% of towns identified in the imagery contained GPD disturbance. If a transect was found in the field to have any GPD disturbance and we had delineated polygons anywhere on the transect, we scored that transect as correct. We correctly identified activity on 126 of 151 transects, of which 103 transects were found to be active and 23 to be inactive. We therefore correctly identified GPD disturbance on 83.44% of transects.

Table 2. Field checking results by polygon, town, and transect. A=active, I=inactive, N=no town, ?=unknown, T=total.

Area	Polygon					Town					Transect				
	A	I	N	?	T	A	I	N	?	T	A	I	N	?	T
Hopi North	20	0	0	0	20	12	0	0	0	12	12	0	0	0	12
%	100					100.00					100.00				
A + I %	100.00					100.00					100.00				
Hopi South	35	6	20	0	61	22	5	19	0	46	20	4	12	2	38
%	0.57	0.10	0.33	0.00		0.48	0.11	0.41	0.00		52.63	10.53	31.58	5.26	
A + I %	0.67					0.59					63.16				
Greasewood	48	1	9	2	60	30	1	6		37	24	1	11		27
%	80	1.67	15	3.33		81.08	2.70	16.22			88.80	3.70	7.41		
A + I %	81.67					83.78					92.50				
Crownpoint	21	9	18		48	15	9	18		42	12	5	7		24
%	43.75	18.75	37.5			35.71	21.43	42.86			50.00	20.83	29.17		
A + I %	62.50					57.14					70.83				
Huerfano	49	20	0		69	25	13	0		38	19	5	0		24
%	71.01	28.99				65.78	34.21				79.17	20.83			
A + I %	100.00					99.99					100.00				
Chinle Valley	42	19	6		67	21	13	6		40	16	8	2		26
%	62.69	28.36	8.96			52.50	32.50	15.00			61.54	30.77	7.69		
A + I %	91.05					85.00					92.31				
TOTAL	215	55	53		325	125	41	49		215	103	23	32		151
%	66.15	16.92	16.31			58.14	19.07	22.79			68.21	15.23	21.19		
% Correct	83.07					77.21					83.44				

Percentage of correctly identified polygons, towns, and transects varied by sampling area. For example, we correctly identified 100% of polygons, towns, and transects on the Hopi North and Huerfano sampling areas (Table 2). Success rates were also high at Chinle Valley (91%, 85%, 92%) and Greasewood (82%, 84%, 93%). Success was much lower at Hopi South and Crownpoint (60±11%).

GPD Distribution

This survey identified 160 ha of apparent GPD disturbance outside the assumed GPD distribution. The new polygons, if confirmed as GPD disturbance, would extend the GPD distribution by up 50 km to the northwest (Figure 9).

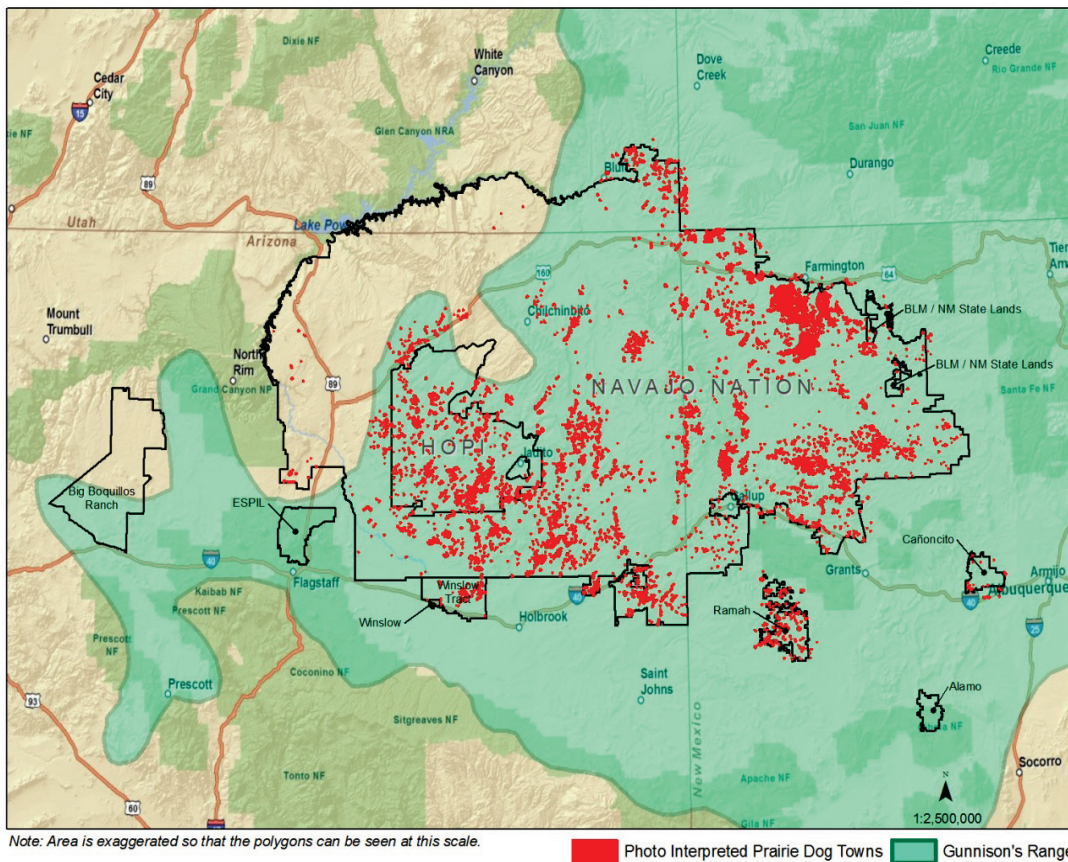

Figure 9. Photo-interpreted prairie dog disturbance. Polygons are enlarged to allow visualization at landscape scale.

Transect Area

We field checked 101, 2 km transects on the Navajo Nation and 50 on the Hopi Reservation. The total distances walked on the transects were approximately 202 and 100 km, respectively. The total area within the triangles delineated by the field transects was approximately 29.16 km², of which 19.63 were on Navajo land and 9.72 were on Hopi land. We were able to delineate active prairie dog polygons on 48 Navajo transects and 25 Hopi transects. On all sub-areas, active areas delineated in the field were substantially larger than polygon areas interpreted from the imagery. The difference ranged from 2.2 times as much area in the field as on the imagery in Lower

Greasewood to 4.5 times as much field area as image area in Hopi North (Table 3). The mean factor describing the relationship between all field and image surveys was 3.6. These missed areas can be used as an indication of the rate of *false negative errors*.

In addition, 16.31% of polygons, 22.79% of towns, and 21.19% of transects delineated showed no evidence of present or past GPD activity. We have areas for polygons only. On the field transects, 13.18 % of the total polygon area was delineated in polygons found to be neither active nor inactive GPD disturbance. The percent of no GPD polygons can be used as an indication of the rate of *false positive errors*.

Table 3. GPD disturbance on field transects versus interpreted imagery, by field study site and notes on dominant vegetation structure.

Study Site	Field Area	Interpreted Area	Ratio	Vegetation Structure
Chinle Valley	58.62	15.53	3.77	Open ground, taller, dense shrub areas, rolling hills
Crownpoint	58.06	14.50	4.00	Shrubs dominant, hilly
Hopi North	97.57	21.59	4.52	
Hopi South	134.65	32.17	4.19	
Huerfano	186.59	61.99	3.01	Intact grasslands, veg. dense but low, rolling hills
Lower Greasewood	118.13	53.66	2.20	Flat, sparse veg., bare ground

Because field checks frequently found two or more delineated polygons to be a single GPD town, and because polygons were often close together, it appeared that only the most heavily-disturbed areas of a colony were showing up on the imagery, and interpreters were drawing polygons around areas of heavy activity rather than entire towns. Based on an assumed daily movement of 500 m (Dustin Long, pers. comm.), we combined all polygons that were ≤ 500 m from another polygon (Figure 10). Aggregating activity polygons thus included the area between closely-situated polygons. Aggregating resulted in 3,450 polygons and increased the total disturbance area to 85,483 ha. This is 2.1 times the initial total area of delineated polygons. This total area was still smaller than the field checks suggested it ought to be, but it more closely approximated the expected disturbance area, based on field checks. We believe the larger polygons that resulted from the aggregation of the disturbance polygons provide a more accurate map of actual prairie dog activity on the ground.

Year-to-Year Changes

On the sub-sample of transects that we re-checked in 2009, the mean active area changed from 12.30 to 13.33. This increase was non-significant (Paired t-test: $t=2.23$, $P=0.096$, $N=12$). Although this change is not statistically significant, a change of this magnitude could be biologically significant if repeated over several years. However, we do not include an annual change factor in our model for two reasons. First, annual rates of change likely vary widely; without more years of data, it is not possible to estimate an accurate annual rate of change. Second, the discrepancy between the field-estimated area and the interpreted area originated

almost entirely from errors of interpretation. We concluded that the current model would not be improved by the addition of a small, questionable annual rate of change.

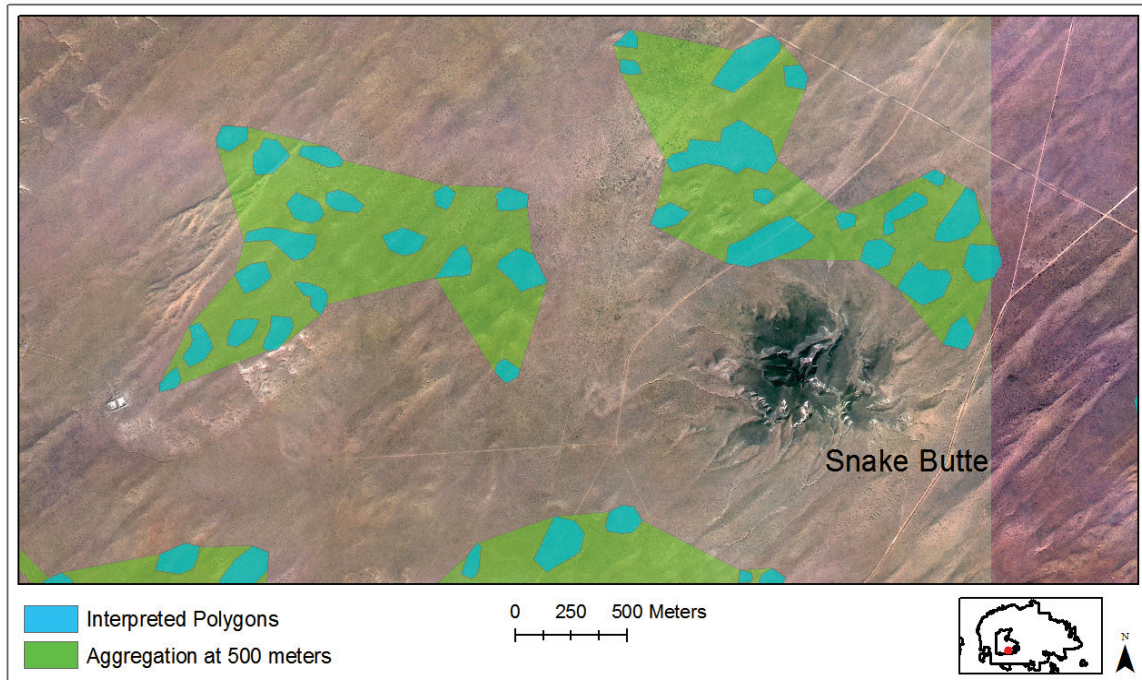

Figure 10. Aggregated polygons within 500 m of one another.

Percent of Area Active

Field checking yielded 207 active and 53 inactive interpreted polygons of prairie dog activity. Areas were 237.29 and 46.93 ha, respectively. Field checks thus indicated that the *proportion of GPD disturbed areas that were active* was 83.49%.

Modeling Active GPD Area

To estimate the area of active GPD disturbance on the ground, we multiplied the active area for each study site by the false positive correction factor (0.1318 false positive rate, 0.8682 correctly identified), to eliminate polygon area that was likely not GPD disturbance. We then multiplied the resulting areas by the false negative correction factors for each study area and added them. This total we then multiplied by the percent of towns found in the field to be active. The model is shown below. The resulting estimated active GPD area on the Navajo and Hopi lands combined is 102,615.36 ha.

$$A_E = \left[\sum_{i=1}^N ((A_{Pi} * E_{FP}) * E_{FNI}) \right] * P_A$$

A_E = Estimated active GPD town area
 A_{Pi} = Photo-interpreted polygon area by study site
 E_{FP} = False positive error factor overall
 E_{FNI} = False negative error factor by study site
 P_A = Proportion of GPD disturbance area active overall

$$\begin{aligned}
 A_E &= 122,907.36 * 0.8349 \\
 &= 102,615.36 \text{ ha}
 \end{aligned}$$

Discussion

The size of the Navajo Nation and the Reservation of the Hopi Tribe alone makes a GPD survey a daunting task. Adding to area the obstacle of limited road access renders a 100% ground survey virtually impossible, or at least financially prohibitive. Hence, when evaluating the utility of DOQQ surveys for GPD, it is advisable to consider the alternatives. Aerial line-intercept transects are expensive, have high error rates, and do not provide 100% coverage or spatial information for GIS analyses. Ground monitoring of randomly-selected sites, as mandated by the Prairie Dog Interstate Working Group, has many of the same problems. Thus, we believe that surveying using digital aerial photos has advantages sufficient to recommend it for several uses.

Method Advantages

A primary advantage of this method is that it allows 100% coverage of huge landscapes. No other method currently in use provides coverage this extensive (~ 8 million ha) for the cost (roughly 40 cents per ha), including field checking, analysis, and report writing.

A second advantage is that the spatial data generated are useful in a variety of GIS spatial analyses. The method is fairly accurate at identifying GPD disturbance, with average accuracy rates of 83.07%, 77.21%, and 83.44% at the polygon, town, and transect scale, respectively. Although it is less accurate at providing areas of disturbance, it is very useful at mapping areas of GPD activity over a large landscape. In combination with vegetation layers and other spatial data such as climate and disturbance data, this type of survey data provides a powerful tool for analyzing distribution, monitoring spatial and temporal changes, modeling habitat suitability, detecting the impacts of human disturbance, and planning for management. One unexpected result from the study is the identification of GPD disturbance that potentially extends the GPD range up to 50 km to the northwest from the previously-known range boundary.

A third major advantage is access. Over landscapes covering millions of hectares where access is limited due to ownership or absence of roads, this method allows for surveys where other methods do not.

Method Disadvantages

The primary disadvantage we discovered during this study was the significant under-estimation of GPD disturbance areas, or a false negative error rate ranging from 200-450%. The method

does accurately identify general areas of GPD activity and serves well to identify focal areas for ground surveys, habitat analysis, or management. Heavily-disturbed areas are evident on the imagery, while lesser-used areas within towns do not seem to be discernable on the imagery. To estimate the areas of GPD disturbance requires field checking to establish a basis for modeling actual activity areas on the ground. The requirement for field data is not unique to this method, however, and in fact less technician time on the ground is required for this method than for most approaches.

One response to the problem of area estimation shows promise. This approach uses GIS to aggregate the highly disturbed polygons, using distance rules based on GPD daily movements. Unfortunately, little data exist on which we can base aggregation rules, and at this time our 500 m rule derives from expert opinion. As more information becomes available on GPD movements, confidence will increase in our aggregation guidelines.

Other disadvantages of the DOQQ method involve smaller sources of error. Towns change over time, such that the accuracy of a survey would seem to be negatively related to the age of the imagery. We found relatively small movements and area changes in GPD activity in the year between the repeated ground surveys. More data on annual changes in GPD disturbance would be needed before it would be possible to know if it would be feasible to incorporate annual rates of change in area modeling, or if annual rates are too unpredictable to be useful. At least for the purposes of this study, the year-to-year rate of change was insignificant when compared to other sources of error. The other potential source of error is the false positive rate. In general, we greatly under-estimated the area of GPD disturbance compared to field surveys, but 13.18% of areas we identified as GPD disturbance showed no evidence of activity on the ground. These false positives could be the result of changes over time; i.e., GPD towns may have been evident at the time of the imagery, or they could have been errors of interpretation. Based on our repeated field checks, we know that an 8.3% change can occur between years. Over several years, this potential for annual change is more than large enough to account for a 13.18% false positive rate. Errors due to changes over time could be eliminated if imagery were available annually. Improved image quality also reduces errors of interpretation. Trends for both these factors are encouraging and should only improve accuracy of the method over time.

None of these disadvantages is insurmountable. Field checking provides information for modeling actual GPD disturbance area on the ground. In addition, assuming error factors being roughly equal among years, changes in polygon distribution over time are useful for large-scale monitoring. In a DOQQ monitoring study of black-tailed prairie dogs in eastern New Mexico, this method detected a northerly shift in town distribution of 36.67 km and a 36.85% reduction in town size over a 7-8 year period, likely due to a plague outbreak (Johnson et al. 2006b).

Variation in Accuracy Across Study Areas

Vegetation density and structure would be expected to obscure GPD burrows and ground disturbance from the air, resulting in under-reporting of town number and area. Taller vegetation and especially hilly terrain might be expected to obscure field observers' line of sight and potentially cause them to miss animals and burrows on the ground. Variation in accuracy among study areas would thus be expected to reflect vegetation structure and topography.

Field checks revealed variation among areas in the accuracy of the DOQQ survey. At the polygon scale, the survey was more accurate in the Chinle Valley, Huerfano, and Lower Greasewood areas, where vegetation was sparse and/or low, than in Crownpoint, where shrubs dominated (Table 2). Thus, as expected, accuracy at identifying disturbance polygons appeared to be generally reduced by complex vegetation structure and/or greater vegetative cover.

Considering the area of GPD towns detected, the effect of vegetation on accuracy was more pronounced. For example, Lower Greasewood, the area with the lowest ratio of field to interpreted GPD disturbance (highest accuracy, Table 3), was characterized by very sparse, low-growing vegetation, and substantial bare ground. In contrast, Crownpoint and Chinle Valley had much higher ratios of actual to interpreted GPD disturbance (lower accuracy, Table 3). Both areas had areas of tall, dense shrubs, which likely made detection of GPD burrows difficult on the imagery. Huerfano's vegetation was dense but low. With dense vegetation but fewer shrubs, this area was probably moderately easy to interpret, and our accuracy was intermediate here.

The effect of terrain is less clear. In hilly areas such as Crownpoint and Chinle Valley, field observers might be expected to miss GPDs obscured by the terrain, thus lowering the ratios of field to interpreted area (and resulting error rates). However, the hilly areas were those in which our area accuracies were lowest. Perhaps field errors balanced even higher interpretation errors in hilly study areas. Alternatively, topography might have affected the field observers' accuracy less than expected.

Conclusions

The Navajo Nation is the largest single manager of suitable habitat for GPD in the species' entire range. Adding habitat within the Reservation of the Hopi Tribe, the two landowners manage a significant portion of the GPD habitat and are stewards of a crucial segment of the population range-wide. This study has confirmed that these two Tribes manage not only potential GPD habitat but also an estimated 102,615 ha of active GPD colonies spread throughout holdings of both Tribes. This estimated occupied area is only 1.9% of the area owned by both Tribes within the GPD range (5,398,126 ha). Thus, even within the lands of the largest individual holders of suitable habitat, only a small proportion of the land harbors GPDs. The results of this study emphasize both the limited GPD population size and the importance of Navajo Nation and Hopi Tribe stewardship for this species.

Education Project

In fulfillment of this grant, the Navajo Natural Heritage Program completed an educational brochure to highlight the importance of GPDs within the natural ecosystem of the Navajo Nation. NNHP calculated that they spent no less than 34 hours for the development of this project. The front of the brochure (Appendix A.1.) exhibits photographs of animals, plants, and the landscape of an idealized prairie dog town. The rear page (Appendix A.2.) contains information on prairie dogs, keystone species, species diversity, and prairie dog predators. A quantity of 3,000 brochures has been ordered for free distribution to Navajo Nation school students, Chapter Houses, and elsewhere.

Matching Fund Obligations

In fulfillment of this grant, the Navajo Natural Heritage Program has kept careful records of its expenditures for the obligatory 25% matching funds (Table 4). In summary, the NNHP zoologist spent 33 days (245 hours) afield, driving 6671 miles, to complete 136 transects. Another 173.5 hours were spent in the office performing a variety of tasks, including: downloading and compiling field data, quarterly- and final-report writing/reviewing, consultation and meeting with NHHM and the Hopi Tribe, compiling budgetary figures, educational brochure work, and administrative oversight for the project. The NNHP has calculated that it spent no less than \$26,132.94 to complete all aspects of this project; this value should be considered as an absolute minimum for our efforts. Although similar calculations of matching obligations were not computed and made available from the Hopi Tribe, we are confident that their work matches that provided by the NNHP.

Table 4. NNHP matching fund obligation.

Activity	No. Units	Cost/Unit	Cost
Administrative oversight	35 hrs	\$34.63 / hour*	\$1,212.05
Field Hours - Zoologist '07 & '08	107 hrs	\$29.58 / hour*	\$3,165.06
Field Hours - Zoologist 2009	138 hrs	\$29.58 / hour*	\$4,082.04
Field Hours – Wildlife Tech. 2009	52.5 hrs	\$14.89 / hour*	\$781.73
Office Hours - Zoologist	173.5 hrs	\$29.58 / hour*	\$5,132.13
Mileage - 2008	2342 miles	\$0.28 / mile	\$655.76
Mileage - 2009	4329 miles	\$0.32 / mile	\$1,385.28
Vehicle Rental - 2008	16 days	\$12.67 / day	\$202.72
Vehicle Rental - 2009	22 days	\$13.86 / day	\$304.82
Field Per Diem	33 days	\$39.00 / day	\$1,287.00
Field Equipment Rental	33 days	\$100.00 / day	\$3,300.00
(*includes 33.19% fringe benefits)	SUBTOTAL		\$21,508.59
Indirect Cost @ 21.5%			\$4,624.35
	TOTAL		\$26,132.94

Literature Cited

Andelt, W.F., P. Schnurr, and A. Seglund. 2003. Evaluation of aerial surveys for estimating acreage of Gunnison's and white-tailed prairie dogs in Colorado and Utah. Internal Report for: Colorado Division of Wildlife and Utah Division of Wildlife Resources.

Biodiversity Legal Foundation, The Predator Project, and J.C. Sharps. 1998. Petition to list the black-tailed prairie dog. 173 pp.

- Brown, D.E., C.H. Lowe, and C.P. Pase. 1979. A digitized classification system for the Biotic Communities of North America, with community (Series) and Association examples for the Southwest. *Journal of the Arizona-Nevada Academy of Science*, Vol. 14(1):1-16.
- Center for Native Ecosystems, Biodiversity Conservation Alliance, Southern Utah Wilderness Alliance, American Lands Alliance, and Forest Guardians, T.T. Williams, Ecology Center, and Sinapu. 2002. Petition for a rule to list the White-tailed prairie dog as threatened or endangered under the Endangered Species Act, and for the designation of critical habitat. 363 pp.
- Comer, P., D. Faber-Langendoen, R. Evans, S. Gawler, C. Josse, G. Kittel, S. Menard, M. Pyne, M. Reid, K. Schulz, K. Snow, and J. Teague. 2003. *Ecological Systems of the United States: A Working Classification of U.S. Terrestrial Systems*. NatureServe, Arlington, Virginia.
- Fitzgerald, J.P., C.A. Meaney, and D.M. Armstrong. 1994. *Mammals of Colorado*. Denver, CO: Denver Museum of Natural History and University Press of Colorado.
- Forest Guardians. 2004. Petition to the U.S. Fish and Wildlife Service to list the Gunnison's prairie dog as an endangered or threatened species under the Endangered Species Act, 16U.S.C. § 1531 et Seq. (1973 as amended), and to designate critical habitat. In the office of Endangered Species, USFWS, USDI.
- Beyer, H.L. 2004. Hawth's Analysis Tools for ArcGIS. Available at <http://www.spatial ecology.com/htools>.
- Johnson, K., L. DeLay, and P. Neville. 2000. Use of satellite imagery to detect prairie dog towns. New Mexico Natural Heritage Program technical report to New Mexico Department of Game and Fish Share With Wildlife.
- Johnson, K, T. Neville, and L. Pierce. 2003. Remote sensing survey of black-tailed prairie dog towns in the historical New Mexico range. New Mexico Natural Heritage Program, NMNHP Publication No. 03-GTR-248, Albuquerque, NM.
- Johnson, K, L. Pierce, and T. Neville. 2004a. Field verification of black-tailed prairie dog remote sensing survey in New Mexico. Natural Heritage New Mexico Publication No. 04-GTR-61, Albuquerque, NM.
- Johnson, K, T. Ostheimer, T. Neville, and J. Smith. 2004b. Evaluation of remote sensing to survey for Gunnison's prairie dogs in New Mexico. Natural Heritage New Mexico Publication No. 04-GTR-264, Albuquerque, NM.
- Johnson, K., T. Neville, and J. Bennett. 2006a. Evaluation of high resolution digital aerial photos to survey for Gunnison's prairie dogs. Natural Heritage New Mexico Publication No. 05-GTR-290, Albuquerque, NM.

- Johnson, K., T. Neville and A. Kirk 2006b. Monitoring black-tailed prairie dog towns in southeastern New Mexico using remote sensing. Natural Heritage NM Publication # 06-GTR-296. Natural Heritage NM, Museum of Southwestern Biology, University of New Mexico, Albuquerque, NM.
- Lillesand, T. M. and R. W. Kiefer. 1987. Remote Sensing and Image Interpretation, 2nd ed. John Wiley and Sons, New York, NY. 721 pp.
- Lowry, J.H., Jr., R.D. Ramsey, K. Boykin, D. Bradford, P. Corner, S. Falzarano, W. Kepner, J. Kirby, L. Langs, J. Prior-Magee, G. Manis, L. O'Brien, T. Sajwaj, K.A. Thomas, W. Rieth, S. Schrader, D. Schrupp, K. Schulz, B. Thompson, C. Velasquez, C. Wallace, E. Waller and B. Wolk. 2005. Southwest Regional Gap Analysis Project: Final Report on Land Cover Mapping Methods, RS/GIS Laboratory, Utah State University, Logan, Utah.
- MacVean, S. and R. Miller. 2005. Summary of aerial surveys and colony monitoring for Gunnison's prairie dogs in Northern Arizona. Arizona Game and Fish Department Report.
- National Wildlife Federation. 1998. Petition to list the black-tailed prairie dog. 66 pp.
- Natural Heritage New Mexico. 2010. NMBiotics Database. University of New Mexico, Albuquerque, NM. Online: <http://nhnm.unm.edu>. Accessed on March 29, 2010.
- Neville, T. and K. Johnson. 2007. Gunnison's prairie dog predictive range model and survey site selection for New Mexico. Natural Heritage New Mexico Publ. No. 07-GTR-320. Natural Heritage New Mexico, University of New Mexico, Albuquerque, NM. 13 p.
- New Mexico Cooperative Fish and Wildlife Research Unit. 2005. SWReGAP vertebrate habitat distribution model: Gunnison's Prairie Dog. Online: <http://fws-nmcfwru.nmsu.edu/swregap/habitatreview/> Last accessed: March 29, 2010.
- Oldemeyer, J.L., D.E. Biggins, B.J. Miller, and R. Crete, editors. 1993. Proceedings of the symposium on the management of prairie dog complexes for the reintroduction of the black-footed ferret. Biological Report 13. July 1993. U.S. Department of the Interior, U.S. Fish and Wildlife Service, Washington, D.C.
- Soil Survey Staff, Natural Resources Conservation Service, United States Department of Agriculture. Soil Survey Geographic (SSURGO) Database for [New Mexico and Arizona]. Available online at <http://soildatamart.nrcs.usda.gov> accessed [2007].
- Soil Survey Staff, Natural Resources Conservation Service, United States Department of Agriculture. U.S. General Soil Map (STATSGO2) for [New Mexico and Arizona]. Available online at <http://soildatamart.nrcs.usda.gov> accessed [2007].

- Seglund, A.E., A.E. Ernst, and D.M. O'Neill. 2005. Gunnison's prairie dog conservation assessment. Western Association of Fish and Wildlife Agencies. Laramie, Wyoming. Unpublished Report. 87 pp.
- USGS National Gap Analysis Program. 2004. Provisional digital land cover map for the Southwestern United States. Version 1.0. RS/GIS Laboratory, College of Natural Resources, Utah State University.
- USGS National Gap Analysis Program. 2007. Digital Animal-Habitat Models for the Southwestern United States. Version 1.0. Center for Applied Spatial Ecology, New Mexico Cooperative Fish and Wildlife Research Unit, New Mexico State University.
- U.S. Fish and Wildlife Service (USFWS). 5 February 2008. 12-month finding on a petition to list the Gunnison's prairie dog as threatened or endangered. Federal Register 73(24):6660-6684.
- Wagner, D.M. and L.C. Drickamer, 2003. Distribution, habitat use, and plague in Gunnison's prairie dogs in Arizona. Arizona Game and Fish Department, Heritage Grant I20009.

Appendix A. Gunnison's Prairie Dog Educational Brochure

A.1. Front page of four-fold educational brochure produced to exhibit importance of Gunnison's Prairie Dog on the Navajo Nation.

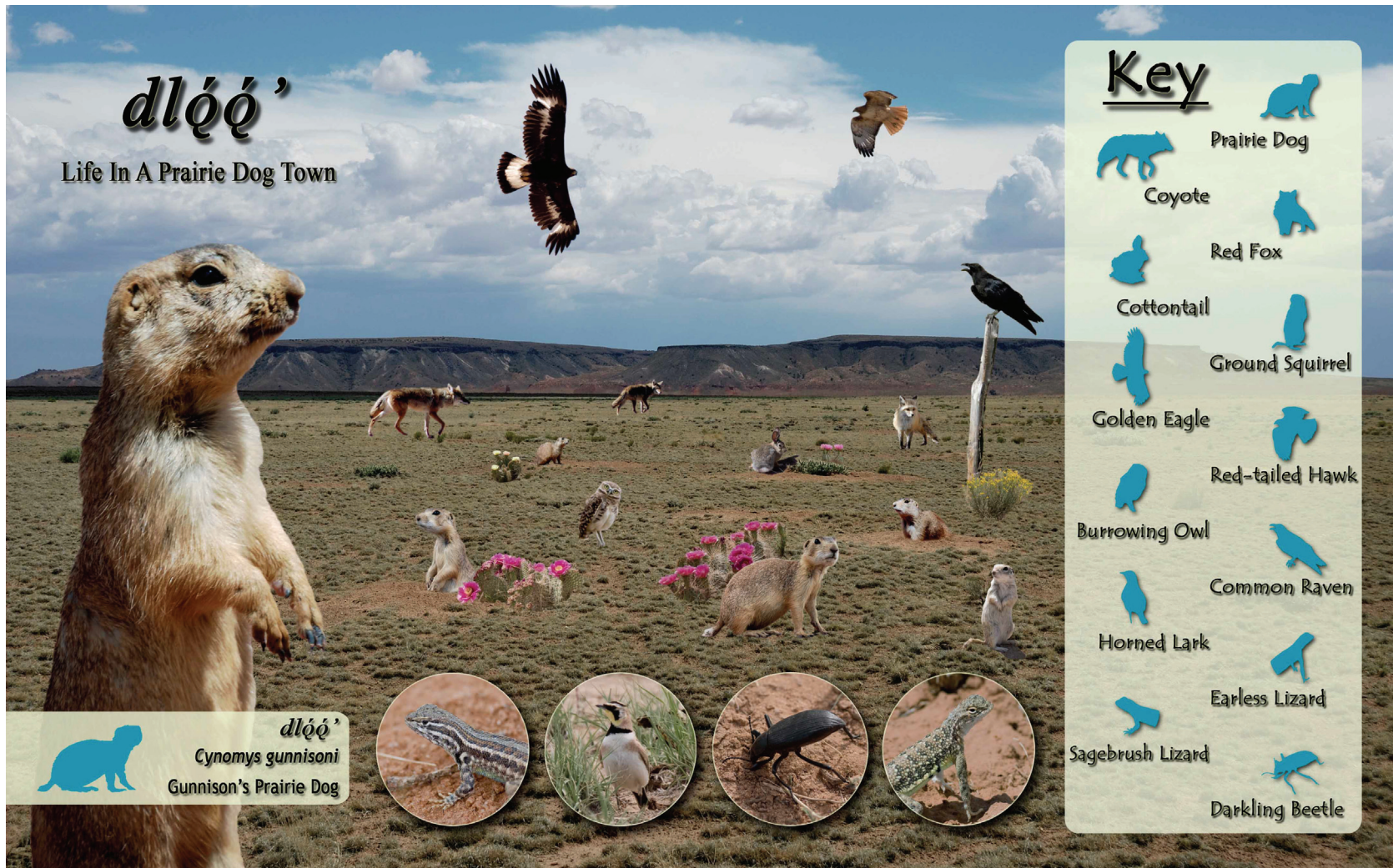

Appendix A.2. Back page of four-fold educational brochure produced to exhibit importance of Gunnison's Prairie Dog on the Navajo Nation.

dlóó'

Life in a prairie dog town

The Navajo Nation is home to one of the largest populations of Gunnison's Prairie Dog (*Cynomys gunnisoni*) in the Southwest. Nearly 25% of the total range for the species is here. Scientists estimate the amount of habitat currently occupied by prairie dogs has declined by 98% compared to historic times. This is because of massive habitat conversion, plague, and eradication programs.

Prairie dogs are social mammals that live in large groups called towns, that may include hundreds of residents. Within a town, prairie dogs section into small family units. They mostly feed on grasses, forbs, and sedges. They can have up to six young and live 4-5 years.



Prairie dogs are a very important part of the natural environment. They are considered a "keystone species" because they have a very large effect on the environment relative to their small size. They help maintain the desert grassland community; dramatic shifts in habitat are experienced if prairie dogs are removed.

Prairie dogs help determine the number and diversity of other species in the desert grasslands. Generally species diversity and abundance is greater inside a prairie dog town as compared to outside. Thus, prairie dogs are also "ecosystem engineers" since they create habitat for many other species.

The burrows of prairie dogs are used by many species of mammals, reptiles, and invertebrates to escape predators. They also use burrows to survive difficult weather conditions like the summer heat and cold winter weather. In fact, scientists have found over 200 animal species using prairie dog towns.

Animals that commonly use prairie dog burrows on the Navajo Nation include:

- Foxes
- Weasels
- Badgers
- Skunks
- Cottontails
- Jackrabbits
- Ground Squirrels
- Deer Mice
- Burrowing Owls
- Gopher Snakes
- Western Rattlesnakes
- Lesser Earless Lizard
- Sagebrush Lizards
- Western Whiptails
- Tiger Salamanders
- Spiders and Insects



Prairie dog burrows:

- are up to 15 feet deep
- have separate chambers for nesting and raising young, food storage, and "bathroom"
- have two entrances for air flow and escaping predators
- help to control flooding and reduce erosion by channeling rain water into lower soil levels
- encourage plant growth by increasing soil aeration and reducing soil compaction.



Prairie dogs themselves serve as food for many predators, such as:

- Black-footed Ferret & other weasels
- Red, Gray & Kit Foxes
- Coyotes
- Badgers
- Golden Eagles
- Ferruginous & Red-tailed Hawks



Black-footed ferrets feed exclusively on prairie dogs.

Prairie dogs crop the vegetation within the town to increase visibility of predators. One or more members of a town are always looking for predators. When one approaches, prairie dogs bark loudly to warn others, then they all escape into their burrows. The open grassland within a town is beneficial to many nesting birds, such as the Mountain Plover, Horned Lark, and sparrows.

Gunnison's Prairie Dogs play a very important role in the desert grassland ecosystem of the Navajo Nation by creating habitat for many animal species, promoting diversity of plant species, and serving as food for many predators.

Suggested Activity:

Walk through several prairie dog towns counting the number of types of animals you see; then compare those numbers you count walking an equal amount of desert grasslands without prairie dogs.

© Navajo Natural Heritage Program

Navajo Nation Department
of Fish and Wildlife



For additional copies, contact:
www.nndfw.org, or nnhp.nndfw.org



burrow diagram: Rick Young, Colorado Division of Wildlife
feeding prairie dog: Nitsch, black-footed ferret: Ryan Hagerly
all other photos: David Miklesic, NNHP